



Page 26-6

ENGINE PROTECTION CONTROLLERS

- Starting with or without power key switch
- Programmable inputs and outputs
- Front LED indicators for engine alarm conditions and diagnostics.



Page 26-7

STAND ALONE GEN-SET CONTROLLERS

- Generator voltage and current control
- Engine protection
- Programmable inputs and outputs
- Programmable alarm properties.



Page 26-8

AUTO MAINS FAILURE (AMF) GEN-SET CONTROLLERS

- Automatic starting of generator and load switching to stand-by emergency source in case of mains failure
- Supervision in “open transition” for contactors, motorised circuit breakers and motorised changeover switches
- Engine protection
- Programmable inputs, outputs and alarms.



Page 26-9

PARALLELING CONTROLLERS FOR MAINS-GENERATOR AND GENERATOR-GENERATOR

- Mains-generator “closed transition” synchronising
- Mains-generator load sharing with source peak demand control
- Generator paralleling supervision (island mode with load sharing).



Page 26-10

REMOTE UNITS

- Remote viewing and control panels
- Remote annunciator for alarm and status indication
- Digital outputs for alarm and status condition remoting.

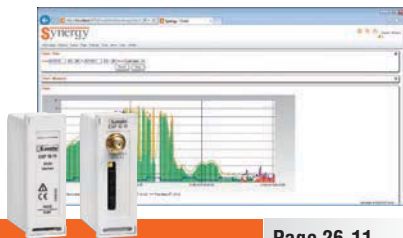

Page 26-11

COMMUNICATION DEVICES, SOFTWARE AND ACCESSORIES

- Communication interfaces
- Additional digital and analog inputs and outputs
- GPRS-GSM module
- Setup and supervision software and APP.

ENGINE AND GENERATOR CONTROLLERS



- Extensive selection of functions to satisfy all application requirements
- Power supply range 12-24VDC for each single product
- Totally programmable inputs, outputs and alarms
- RS232, RS485, USB, Ethernet communication interface
- Engine control by CANbus
- Setup and supervision software
- Modem control for sending alarm messages and emails.

Engine and generator controllers

SEC. - PAGE

Engine protection controllers	26	6
Stand alone gen-set controllers	26	7
Automatic mains failure (AMF) gen-set controllers	26	8
Paralleling controllers for mains-generator and generator-generator	26	9
Remote units	26	10
Communication devices and accessories	26	11
Software	26	12

Dimensions

26 13

Characteristics



	ENGINE PROTECTION CONTROLLERS			STAND ALONE GEN-SET CONTROLLERS		
	RGK30	RGK20	RGK40	RGK600 SA RGK601 SA	RGK700 SA	RGK800 SA
Generator voltage control	–	L-N ❶	L1-L2-L3/N	L1-L2-L3-N	L1-L2-L3-N	L1-L2-L3-N
Current control	–	–	L1	L1-L2-L3	L1-L2-L3	L1-L2-L3-N
Rated frequency	–	50/60Hz	50/60Hz	50/60Hz	50/60Hz	50/60/400Hz
Digital inputs n°	4	4	6	5	7	9
Digital outputs n°	2 (Relay)	3 (SSR)	1 (Relay) + 4 (SSR)	6 (SSR)	3 (Relay) + 4 (SSR)	3 (Relay)+6 (SSR)+1 (SO)
Engine running inputs	“D+” and “AC”	“D+” and “AC”	“D+” and “AC”	“D+”	“D+” and “AC”	“D+” and “AC”
Ohmic inputs for fuel-pressure-temperature	–	–	–	●	●	●
Remote control	–	–	–	–	●	●
CANbus interface	–	–	–	RGK601SA	●	●
Rated battery voltage	12/24VDC	12/24VDC	12/24VDC	12/24VDC	12/24VDC	12/24VDC
Power supply range	9-33VDC	9-35VDC	9-35VDC	7-33VDC	7-33VDC	7-33VDC
Mains voltage control	–	–	–	–	–	–
Rated voltage range	–	10-277VAC	100-415VAC	100-480VAC	30-600VAC	30-600VAC
VT programming	–	–	●	●	●	●
Rated input current	–	–	5A	5A/1A	5A/1A	5A/1A
TRMS voltage measurement	–	–	●	●	●	●
TRMS current measurement	–	–	●	●	●	●
Display	–	7 digit LCD	4-digit LCD	Graphic backlight LCD, 128x80 pixels	Graphic backlight LCD, 128x80 pixels	Graphic backlight LCD, 128x80 pixels
Engine running magnetic pick-up input	–	–	–	RGK600SA	●	●
Engine speed input	“W”	“W” or generator frequency	“W” or generator frequency	“W” or generator frequency or “Pick-up” (RGK600SA)	“W” or generator frequency or “Pick-up”	“W” or generator frequency or “Pick-up”
Auxiliary analog input	–	–	–	–	–	●
I/O expansion	–	–	–	RGK RR	RGK RR	3 x EXP... + RGK RR
USB/Optical port on front	–	–	–	●	●	●
Wi-Fi port on front	–	–	–	●	●	●
USB port at rear	–	–	–	–	–	EXP1010
Ethernet port with Web server function	–	–	–	–	–	EXP1013
GPRS/GSM modem	–	–	–	–	–	EXP1015
RS232 serial port	–	● (TTL)	● (TTL)	–	●	EXP1011
RS485 serial port	–	–	–	–	–	●
Event logging	–	–	–	●	●	●
RTC (Real Time Clock)	–	–	–	–	–	●
Programmable Inputs/Outputs	–	●	●	●	●	●
PLC logic function	–	–	–	–	●	●
Alarms n°	6	13	25	59	60	60
User alarms n°	–	1	1	4	8	8
Alarm property customising	–	●	●	●	●	●
Texts for alarms, events and parameters	–	–	–	●	●	●
Multilanguage (type) n°	–	–	–	5 (GB - I - F - P - E)❷	5 (GB - I - F - P - E)❷	5 (GB - I - F - P - E)❷
Upload languages	–	–	–	●	●	●
Load sharing	–	–	–	–	–	–
Generator paralleling	–	–	–	–	–	–
Mains-generator synchronising (closed transition)	–	–	–	–	–	–
IEC front degree of protection	IP41	IP41	IP54	IP54 ❸	IP65	IP65
Certifications	cULus, EAC	cULus, EAC	cULus, EAC	cULus, EAC	cULus, EAC	cULus, EAC

❶ Frequency only.

❷ Controller uploading of other multilanguage sets.

❸ IP65 with optional gasket seal.



	AUTO MAINS (AMF) GEN-SET CONTROLLERS			PARALLELING / LOAD SHARING	
	RGK600 RGK601	RGK700	RGK800	RGK900	RGK900 SA
Generator voltage control	L1-L2-L3-N	L1-L2-L3-N	L1-L2-L3-N	L1-L2-L3-N	L1-L2-L3-N
Current control	L1-L2-L3	L1-L2-L3	L1-L2-L3-N	L1-L2-L3-N	L1-L2-L3-N
Rated frequency	50/60Hz	50/60Hz	50/60/400Hz	50/60/400Hz	50/60/400Hz
Digital inputs n°	5	7	9	13	13
Digital outputs n°	6 (SSR)	3 (Relay) + 4 (SSR)	3 (Relay)+ 6 (SSR) + 1(SO)	3 (Relay)+ 6 (SSR) + 1(SO)	3 (Relay)+ 6 (SSR) + 1(SO)
Engine running inputs	"D+"	"D+" and "AC"	"D+" and "AC"	"D+" and "AC"	"D+" and "AC"
Ohmic inputs for fuel-pressure-temperature	●	●	●	●	●
Remote control	–	●	●	●	●
CANbus interface	RGK601	●	●	●	●
Rated battery voltage	12/24VDC	12/24VDC	12/24VDC	12/24VDC	12/24VDC
Power supply range	7-33VDC	7-33VDC	7-33VDC	7-36VDC	7-36VDC
Mains voltage control	–	L1-L2-L3-N	L1-L2-L3-N	L1-L2-L3-N	–
Rated voltage range	100-480VAC	30-600VAC	30-600VAC	30-600VAC	30-600VAC
VT programming	●	●	●	●	●
Rated input current	5A/1A	5A/1A	5A/1A	5A/1A	5A/1A
TRMS voltage measurement	●	●	●	●	●
TRMS current measurement	●	●	●	●	●
Display	Graphic backlight LCD, 192x112 pixels	Graphic backlight LCD, 128x80 pixels	Graphic backlight LCD, 128x80 pixels	Graphic backlight LCD, 128x112 pixels	Graphic backlight LCD, 128x112 pixels
Engine running magnetic pick-up input	RGK600	●	●	●	●
Engine speed input	"W" or generator frequency (RGK600) or "Pick-up"	"W" or generator frequency or "Pick-up"	"W" or generator frequency or "Pick-up"	"W" or generator frequency or "Pick-up"	"W" or generator frequency or "Pick-up"
Auxiliary analog input	–	–	●	●	●
I/O expansion	RGK RR	RGK RR	3 x EXP... + RGK RR	4 x EXP... + RGK RR	4 x EXP... + RGK RR
USB/Optical port on front	●	●	●	●	●
Wi-Fi port on front	●	●	●	●	●
USB port at rear	–	–	EXP1010	EXP1010	EXP1010
Ethernet port with Web server function	–	–	EXP1013	EXP1013	EXP1013
GPRS/GSM modem	–	–	EXP1015	EXP1015	EXP1015
RS232 serial port	–	●	EXP1011	EXP1011	EXP1011
RS485 serial port	–	–	●	●	●
Event logging	●	●	●	●	●
RTC (Real Time Clock)	–	–	●	●	●
Programmable Inputs/Outputs	●	●	●	●	●
PLC logic function	–	●	●	●	●
Alarms n°	59	60	60	67	67
User alarms n°	4	8	8	16	16
Alarm property customising	●	●	●	●	●
Texts for alarms, events and parameters	●	●	●	●	●
Multilanguage (type) n°	5 (GB - I - F - P - E)Ⓜ	5 (GB - I - F - P - E)Ⓜ	5 (GB - I - F - P - E)Ⓜ	5 (GB - I - F - P - E)Ⓜ	5 (GB - I - F - P - E)Ⓜ
Upload languages	–	●	●	●	●
Load sharing	–	–	–	●	●
Generator paralleling	–	–	–	–	●
Mains-generator synchronising (closed transition)	–	–	–	●	–
IEC front degree of protection	IP54 Ⓜ	IP65	IP65	IP65	IP65
Certifications	cULus, EAC	cULus, EAC	cULus, EAC	cULus	cULus

A SUPERIOR CLASS!



● CUSTOMISING OPTION

There is a customising slot available on the front to show controller brand name, logo, trademark, part number, brief indication or wording, etc.

● PROGRAMMING OPTICAL PORT

The optical port on the panel front, using a standard USB or Wi-Fi point, allows to communicate with a PC, smartphone and tablet, to carry out programming, diagnostics and data download, without removing power to the electric panel.

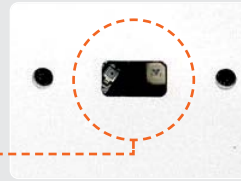

● COMPACT SIZE

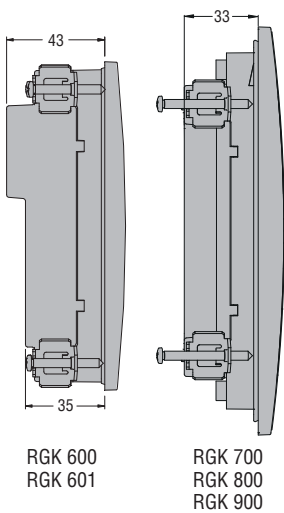

Trim frame profile and reduced total depth simplify installation of the controllers also in very compact electric panels.

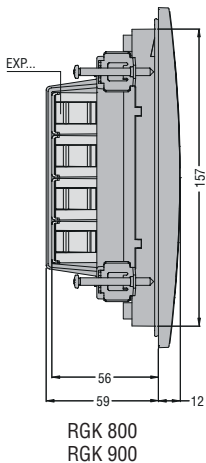

● IP65 DEGREE OF PROTECTION

The controller front and the internal display frame seal have been designed to warrant an **IP65** protection degree (optional IP65 gasket for RGK 600-RGK 601). This with the **UV film** also allow outdoor installation.



● INSTALLATION

The fixing with **metal screws** guarantees excellent adhesion over time.



● CABLING AND EXPANSION MODULE FIXING SYSTEM

The controller rear has 4 fitting slots to secure cables connected to the terminals with cable ties, in an orderly way inside the electric panel. In addition, a plastic retainer is standard supplied to keep the expansion modules in place when installed in applications with strong vibrations.

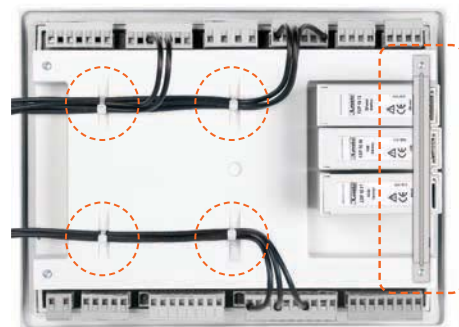

RGK 800
RGK 900

● EXPANDABILITY

Basic RGK 800 and RGK 900 controller functions can be easily extended using up to 4 EXP series expansion modules:

- Digital and analog inputs and outputs
- Opto-isolated static outputs
- Relay outputs
- Opto-isolated RS232 interface
- Opto-isolated RS485 interface
- Opto-isolated Ethernet interface with Web server function
- Data logging and clock-calendar (RTC)
- GPRS/GSM modem



RGK 800 (3 modules)
RGK 900 (4 modules)

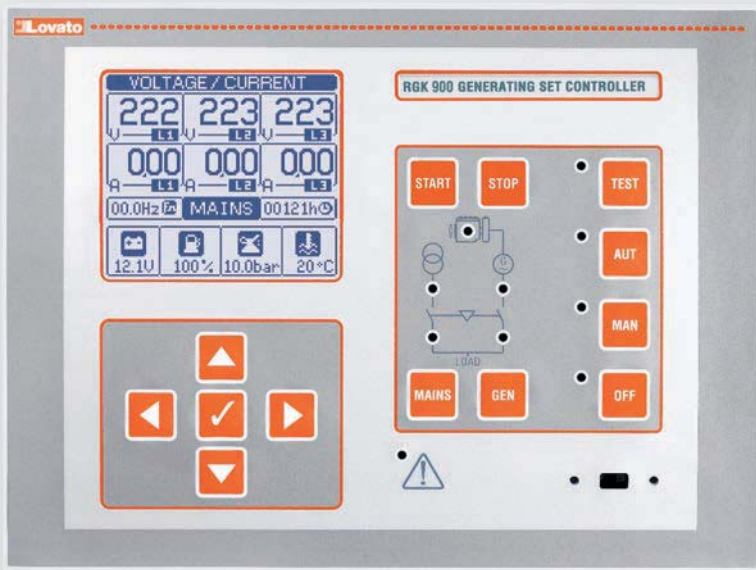

EXPANDABILITY

An extensive selection of modules is available to increase the controller functionality.

GPRS/GSM MODEM

Among the expansion modules, there is a GPRS/GSM modem, automatically configured by genset controller.

MAINTENANCE

Maintenance supervision at programmed intervals.

STREAMLINE DESIGN

The controller has an ergonomic design and, at the same time, particular care has been given to details.

GPRS/GSM MODEM



Once a data-enabled SIM card is inserted, RGK 800 - RGK 900 controllers can send SMS and email messages with alarm and event conditions as well as the latest logged events to a FTP server.

OPTO-ISOLATED ETHERNET INTERFACE WITH WEB SERVER FUNCTION



Web Browsing of the single controller connected in Ethernet by EXP10 13 expansion module.

CANBUS COMMUNICATION PORT

Most models are standard equipped with CAN-J1939 communication port.

PLC FUNCTION

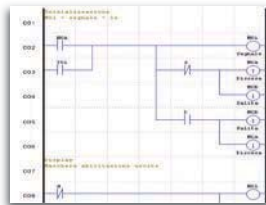

Capability to combine together internal status of controllers with signals incoming from the field to activate outputs and generate alarms.

LOAD MANAGEMENT

There are different methods of controlling the load conditions; each controller has special parameters functions as follows:

- RGK 600 - RGK 700 - RGK800 types: load shedding and dummy load modes
- RGK 900 types: base-load and peak shaving modes.

PARALLELING

RGK 900 and RGK 900SA controllers can control the switching between the mains and generators without having to switch off the power supply to the load. In addition, they can control the paralleling connection of two or more generators sharing in this way the load on more than one source. The RGK 900MC can control and synchronise mains parallel operation with a power bus composed by a series of generating sets.

REMOTE UNITS

Remote displays panels



There are "mirror" display units available to remotely operate as if in front of the generating set.

Remote annunciator



A remote display can view alarm conditions and can be operated for silencing them.

Alarm-state relay unit

The relay unit allows to transmit, on volt-free contacts, the status and alarms of RGK... controllers.



SUPERVISION SOFTWARE

Synergy is web-based and provides for an easy and efficient way to monitor and control electrical installations as well as field equipment.

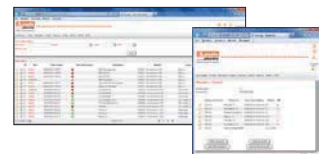

With this versatile system, the user can parameterise controllers, get data-log files and commands carried out, compile graphic pages and charts and implement access level management.



Server-multiclient system based on MS SQL RDBMS with web-browser interface.

Simultaneous management of different communication channels with independent configuration (protocols, speed rate, RS232, RS485, Ethernet, modem).

Engine protection controllers



RGK 30



RGK 20

Order code	Description	Qty per pkg	Wt
		n°	[kg]
RGK 30	12/24VDC for external start-stop key switch	1	0.160
RGK 20	12/24VDC, built-in power supply key switch, with TTL programming port	1	0.270

General characteristics for RGK 30

OPERATOR INTERFACE

- 2 programming key buttons
- 1 LED indicator for engine status
- 1 LED indicator for glow plug pre-heating
- 5 LED indicators for alarm status
- Remote starting only.

INPUTS/OUTPUTS

- Digital inputs: 3 negative and 1 positive (start/stop by remote key switch)
- Digital outputs: 2 relay (1 programmable).

Certifications and compliance

Certifications obtained: UL Listed, for USA and Canada (cULus-File E93601), as Auxiliary Devices-Generator controllers; GOST TR-CU.

Compliant with standards: IEC/EN 61010-1, IEC/EN 61000-6-2, EN 55011, UL 508, CSA C22.2 n° 14.

General characteristics for RGK 20

OPERATOR INTERFACE

- 1 ON-OFF power supply key selector switch
- 1 semi-automatic engine START button
- 2 programmable key buttons
- 7 digit LCD display (Hours, Hz, VBatt)
- 1 LED indicator for engine status
- 1 LED indicator for glow plug pre-heating
- 5 LED indicators for alarm status
- Local or remote starting.

INPUTS/OUTPUTS

Programmable functions:

- Generator frequency input
- Digital inputs: 3 negative and 1 positive
- Digital outputs: 3 static (1 programmable)
- Inputs, outputs and alarms, all with programmable properties.

ADDITIONAL FEATURES

- Quick set-up with PC software (TTL/RS232 serial port).

Certifications and compliance

Certifications obtained: EAC, UL Listed, for USA and Canada (cULus-File E93601), as Auxiliary Devices-Generator controllers.

Compliant with standards: IEC/EN 61010-1, IEC/EN 61000-6-2, IEC/EN 61000-6-3, UL 508, CSA C22.2 n° 14.

Stand alone gen-set controllers



RGK 40

new



RGK 600SA - RGK 601SA

new



RGK 700SA - RGK 800SA

Order code	Description	Qty per pkg	Wt [kg]
RGK 40	12/24VDC, built-in power key switch, with TTL programming port	1	0.400
RGK 600SA	12/24VDC, graphic LCD, USB/optical and Wi-Fi point programming port on front, W/Pick-up speed input, IP54	1	0.540
RGK 601SA	12/24VDC, graphic LCD, USB/optical and Wi-Fi point programming port on front, CANbus port, IP54	1	0.540
RGK 700SA	12/24VDC, graphic LCD, RS232 serial port and USB/optical and Wi-Fi point programming port on front, CANbus port, IP65	1	0.900
RGK 800SA	12/24VDC, graphic LCD, RS485 serial port and USB/optical and Wi-Fi point programming port on front, CANbus port, IP65. Expandible with EXP... modules	1	0.980

Programmable functions and properties

Characteristics	RGK 6...SA	RGK 700SA	RGK 800SA
Inputs	5	7	9
Relay outputs	–	3	3
Protected static outputs	6	4	7

Order code	Description
------------	-------------

ACCESSORY FOR RGK 600SA AND RGK 601SA

RGK X00	IP65 gasket seal for internal display frame
----------------	---

EXPANSION MODULES FOR RGK 800SA

Inputs and outputs.

EXP10 00	4 opto-isolated digital inputs
EXP10 01	4 opto-isolated static outputs
EXP10 02	2 digital inputs and 2 static outputs, opto-isolated
EXP10 03	2 relay outputs rated 5A 250VAC
EXP10 04	2 opto-isolated analog inputs 0/4-20mA or PT100 or 0-10V or 0...±5V
EXP10 05	2 opto-isolated analog outputs 0/4-20mA or 0-10V or 0...±5V
EXP10 08	2 opto-isolated digital inputs and 2 relay outputs rated 5A 250VAC

Communications interface.

EXP10 10	Opto-isolated USB interface
EXP10 11	Opto-isolated RS232 interface
EXP10 12	Opto-isolated RS485 interface
EXP10 13	Ethernet interface with Web server function
EXP10 15	GPRS/GSM modem

Synergy supervision software
See Section 27.

EXP series expansion modules
See Section 27, page 2.

General characteristics for RGK 40

OPERATOR INTERFACE

- 1 ON-OFF power supply key selector switch
- 1 semi-automatic engine START button
- 2 programming key buttons
- 4 digit LED display (V, A, kVA, Hours, Vbatt, Hz)
- 6 LED indicators for measurements/readings
- 2 LED indicators for genset status indication
- 1 LED indicator for glow plug pre-heating
- 8 LED indicators for alarm status
- Local and remote starting.

INPUTS/OUTPUTS

Programmable functions:

- VAC inputs: Generator L1-L2-L3/N
- Digital inputs: 5 negative and 1 positive
- Digital outputs: 1 relay and 4 static
- Programmable properties for inputs, outputs and alarms.

ADDITIONAL FEATURES

- Quick set-up with PC software (TTL/RS232 port)
- Certifications: EAC; UL Listed, for USA and Canada (cULus-File E93601), as Auxiliary Devices - Generator controller.

General characteristics for

RGK 600SA - RGK 601SA - RGK 700SA - RGK 800SA

- VAC inputs: Generator L1-L2-L3-N
- Single, two and three phase voltage control, with or without neutral
- Rated measurement voltage range:
 - 50-576VAC for RGK 600SA and RGK 601SA
 - 30-720VAC for RGK 700SA and RGK 800SA
- Frequency measurement range: 45-65Hz
- Programmable VT ratio
- Current measurement range (3 PH): 0.050-6A or 0.050-1.2A
- Graphic LCD: 128x80 pixels with backlight
- 1 USB/optical and Wi-Fi port on front for programming
- Engine running detection: "D+", generator voltage and frequency
- 2 engine speed inputs: "W" or Magnetic "Pick-up" (RGK 601SA excluded)
- 1 CANbus-J1939 port (RGK 600SA excluded)
- 3 analog ohmic inputs for oil pressure, engine temperature and fuel level control
- 1 built-in alarm remoting port
- Non-volatile memory for event storage
- Alarm, event and parameter text in 5 languages
- Alarm text customisable (8 alarms)
- Event log
- Modbus-RTU and Modbus-ASCII protocols
- Customisation manager software available; compatible with Synergy software
- Certifications: EAC; UL Listed, for USA and Canada (cULus - File E93601), as Auxiliary Devices - Generator controllers.

For RGK 700SA - RGK 800SA only

- PLC logic for inputs, outputs and internal status
- 1 communication port: RS232 for RGK700SA; RS485 for RGK 800SA
- Degree of protection: IEC IP65 on front; suitable for use with UL/CSA Type 4X outdoor enclosure installation.

For RGK 800SA only

- Neutral current measurement range: 0.050-6A or 0.050-1.2A
- 400Hz frequency support
- 1 programmable analog input
- Modbus-TCP communication protocol
- Current leakage control towards earth/ground
- Clock-calendar (RTC).

MAIN FUNCTIONS FOR RGK 600SA-RGK 601SA-RGK 700SA-RGK 800SA

- Menus for quick selection of rated parameter settings
- "Autocall" function for automatic sending of emails and/or SMS at predefined events/alerts
- Generator controls: phase sequence, maximum and minimum voltage and frequency, voltage asymmetry
- Programmable maintenance.



EXP 10...

new

STAND ALONE APPLICATION

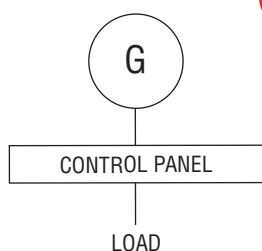

new

Automatic mains failure (AMF) gen-set controllers



RGK 600 - RGK 601

new

new



RGK 700 - RGK 800

Order code	Description	Qty per pkg	Wt [kg]
		n°	
RGK 600	12/24VDC, graphic LCD, USB/optical and Wi-Fi point programming port on front, W/Pick-up speed input	1	0.540
RGK 601	12/24VDC, graphic LCD, USB/optical and Wi-Fi point programming port on front, CANbus port	1	0.540
RGK 700	12/24VDC, graphic LCD, with RS232 port and USB/optical and Wi-Fi point programming port on front, CANbus port, IP65	1	0.880
RGK 800	12/24VDC, graphic LCD with RS485 port and USB/optical and Wi-Fi point programming port on front, CANbus port, IP65. Expandible with EXP... modules	1	0.880

Programmable functions and properties

Characteristic	RGK 600	RGK 601	RGK 700	RGK 800
Inputs	5	5	7	9
Relay outputs	–	–	3	3
Protected static outputs	6	6	4	7

Order code	Description
------------	-------------

ACCESSORY FOR RGK 600 AND RGK 601

RGK X00 IP65 gasket seal for internal display frame

EXPANSION MODULES FOR RGK 800

Inputs and outputs.

EXP10 00	4 opto-isolated digital inputs
EXP10 01	4 opto-isolated static outputs
EXP10 02	2 digital inputs and 2 static outputs, opto-isolated
EXP10 03	2 relay outputs rated 5A 250VAC
EXP10 04	2 opto-isolated analog inputs 0/4-20mA or PT100 or 0-10V or 0...±5V
EXP10 05	2 opto-isolated analog outputs 0/4-20mA or 0-10V or 0...±5V
EXP10 08	2 opto-isolated digital inputs and 2 relay outputs rated 5A 250VAC

Communications interface.

EXP10 10	Opto-isolated USB interface
EXP10 11	Opto-isolated RS232 interface
EXP10 12	Opto-isolated RS485 interface
EXP10 13	Ethernet interface with Web server function
EXP10 15	GPRS/GSM modem



EXP 10...

new

new

AMF (AUTOMATIC MAINS FAILURE) APPLICATION

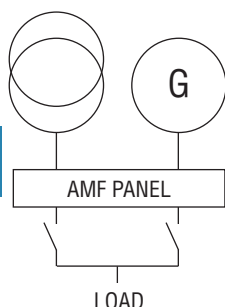

General characteristics for

RGK 600 - RGK 601 - RGK 700 - RGK 800

- VAC inputs: Mains and generator L1-L2-L3-N
- Voltage control for one, two and three phase systems with or without neutral
- Rated measurement voltage:
 - 480VAC for RGK 600 and RGK 601
 - 600VAC for RGK 700 and RGK 800
- Rated measurement voltage range:
 - 50-576VAC for RGK 600 and RGK 601
 - 30-720VAC for RGK 700 and RGK 800
- Frequency measurement range: 45-65Hz
- Programmable VT ratio
- Current measurement range (3 PH): 0.050-6A or 0.050-1.2A
- Graphic LCD: 128x80 pixels with backlight
- 1 USB/optical and Wi-Fi port on front for programming
- Engine running detection: “D+”, generator voltage and frequency
- 2 engine speed inputs: “W” or Magnetic “Pick-up” (RGK 601 excluded)
- 1 CANbus-J1939 port (RGK 600 excluded)
- 3 analog ohmic inputs for oil pressure, engine temperature and fuel level control
- 1 built-in alarm remoting port
- Non-volatile memory for event storage
- Alarm, event and parameter text in 5 languages
- Alarm text customisable (8 alarms)
- Event log
- Modbus-RTU and Modbus-ASCII communication protocols
- Customisation manager software available; compatible with **Synergy** software.

For RGK 700 – RGK 800 only

- PLC logic for inputs, outputs and internal status
- 1 communication port: RS232 for RGK700; RS485 for RGK 800
- Degree of protection: IEC IP65 on front; suitable for use with UL/CSA Type 4X outdoor enclosure installation.

For RGK 800 only

- Neutral current measurement range: 0.050-6A or 0.050-1.2A
- 400Hz frequency support
- 1 programmable analog input
- Modbus-TCP communication protocol
- Current leakage control towards earth/ground
- Clock-calendar (RTC).

MAIN FUNCTIONS FOR RGK 600-RGK 601-RGK 700-RGK 800

- Menus for quick selection of rated parameter settings
- “Autocall” function for automatic sending of emails and/or SMS at predefined events/alerts
- Generator controls: Phase sequence, maximum and minimum voltage and frequency, voltage asymmetry
- Programmable maintenance.

Certifications and compliance

Certifications obtained: EAC; UL Listed, for USA and Canada (cULus - File E93601), as Auxiliary Devices - Generator controllers.

Compliant with standards: IEC/EN 61010-1, IEC/EN 61000-6-2, IEC/EN 61000-6-3, UL 508, CSA C22.2 n° 14.

Synergy supervision software See Section 27.

EXP series expansion modules See Section 28, page 2.

Paralleling controllers for mains-generator and generator-generator



RGK 900SA - RGK 900

new

new

new

Order code	Description	Qty per pkg	Wt [kg]
		n°	[kg]
Stand-alone controller.			
RGK 900SA	Paralleling control among generating sets. 12/24VDC, graphic LCD, RS485 port and USB/optical and Wi-Fi point programming port on front. Expandable with EXP... modules	1	1.040
AMF (Automatic Mains Failure) controller.			
RGK 900	Mains-generator paralleling control. 12/24VDC, graphic LCD, with RS485 port, USB/optical and Wi-Fi point programming port on front. Expandable with EXP... modules	1	1.040
Mains-ATS (Automatic Transfer Switching) controller.			
RGK 900 MC	Control of mains, automatic transfer switching (ATS), and paralleling on multiple generators controlled by RGK 900SA. 12/24VDC, graphic LCD, with RS485 port and USB/optical and Wi-Fi point programming port. Expandable with EXP... modules	1	0.940

Order code	Description
EXPANSION MODULES FOR RGK 900... Inputs and outputs.	
EXP10 00	4 opto-isolated digital inputs
EXP10 01	4 opto-isolated static outputs
EXP10 02	2 digital inputs and 2 static outputs, opto-isolated
EXP10 03	2 relay outputs rated 5A 250VAC
EXP10 04	2 opto-isolated analog inputs 0/4-20mA or PT100 or 0-10V or 0...±5V
EXP10 05	2 opto-isolated static outputs 0/4-20mA or 0-10V or 0...±5V
EXP10 08	2 opto-isolated digital inputs and 2 relay outputs rated 5A 250VAC
Communications interface.	
EXP10 10	Opto-isolated USB interface
EXP10 11	Opto-isolated RS232 interface
EXP10 12	Opto-isolated RS485 interface
EXP10 13	Ethernet interface with web server function
EXP10 15	GPRS/GSM modem



EXP 10...

new

EXP series expansion modules
See Section 28, page 2.

General characteristics

- VAC inputs: Mains L1-L2-L3-N for RGK 900 only
- VAC inputs: Generator L1-L2-L3-N
- Voltage measurement rated value: 600VAC (UL/CSA)
- Voltage measurement range: 30-720VAC
- Frequency measurement range: 45-65Hz or 360-440Hz
- Programmable VT ratio
- Current measurement input (3 PH+N): 0.05-6A or 0.05-1.2A
- Fourth CT for neutral measurement or earth/ground leakage detection
- Graphic LCD, 128x112 pixels with backlight
- 13 digital inputs
- 3 relay outputs rated 8A 250VAC
- 6 static outputs rated 2A, protected
- 1 static output 50mA
- Engine running detection: "D+" generator voltage and frequency
- 1 engine speed input: "W" or "Magnetic Pick-up"
- 3 analog ohmic inputs for oil pressure, engine temperature and fuel level control
- 1 programmable analog input
- 2 analog outputs for engine speed control (governor) / voltage regulator (AVR)
- Alarm-event-parameter text in 5 languages (Web upload)
- Alarm text customisable (16 alarms)
- Event log
- Modbus-RTU, Modbus-ASCII and Modbus-TCP communication protocols
- Boolean logic for inputs, outputs and internal status
- Customisation manager software available; compatible with Synergy software
- Degree of protection: IEC IP65 on front; suitable for use with UL/CSA Type 4X outdoor enclosure installation
- Built-in buzzer
- Multi-level passwords
- Sleep function (power saving mode)
- Synchronising and load sharing.

MAIN FUNCTIONS

- Menus for quick selection of rated parameter settings
- "Autocall" function for automatic sending of emails and/or SMS at predefined events/alarms
- Mains (for RGK 900 only) / Generator controls: Phase sequence, phase loss, max and min voltage and frequency, voltage asymmetry
- Programmable maintenance at various intervals
- Current leakage control towards earth/ground
- Mains-generator synchronising (ATS closed transition)
- Mains in base-load with generator in peak shaving
- Paralleling supervision of generators (island mode)
- Generating set start scheduling.

Certifications and compliance

Certifications obtained: UL Listed for USA and Canada (cULus - File E93601), as Auxiliary Devices, Generator controllers.
Compliant with standards: IEC/EN 61010-1, IEC/EN 61000-6-2, IEC/EN 61000-6-3, UL 508, CSA C22.2 n° 14.

MAINS-GENERATOR PARALLELING	ISLAND MODE	ATS AND PARALLELING OF MAINS WITH MULTIPLE GENSETS
<p>RGK 900 is designed for mains-generator synchronising applications, such as:</p> <ol style="list-style-type: none"> Single generator in maintained parallel with the mains in "base-load" mode (generator power supplied at a steady rate) Single generator in maintained parallel with the mains, in peak-shaving mode (import-export - mains power is limited to constant value and load peaks during heavy demand for power are supplied by generator) Single generator in AMF with temporary parallel with the mains (for emergency, with AMF in closed transition). 	<p>RGK 900SA is designed for applications with load sharing on an isolated bus, without mains:</p> <ol style="list-style-type: none"> Parallel among generators working together in island mode on power bus with load shared among them Generators connected together to maintain the power reserve (total power available minus load power) within a preset range, switching on and off generators according to a priority level. 	<p>Combination of RGK 900SA and RGK 900MC units is designed for load govern controls with multiple generators in parallel on power bus and mains. In these circumstances, the RGK 900MC unit controls, in base-load or peak-shaving mode, the mains and power bus composed by multiple generators, each controlled by an RGK 900SA.</p>

Remote access devices



RGK 800 RD



RGK RA

new

Order code	Description	Qty per pkg	Wt [kg]
RGK 800 RD SA	Remote display panel for RGK 800SA, 12/24VDC, IP65 protection degree	1	0.820
RGK 800 RD	Remote display panel for RGK 800, 12/24VDC, IP65 protection degree	1	0.820
RGK 900 RD SA	Remote display panel for RGK 900SA, 12/24VDC, IP65 protection degree	1	0.980
RGK 900 RD	Remote display panel for RGK 900, 12/24VDC, IP65 protection degree	1	0.980
RGK RA	Remote annunciator, graphic LCD, touch screen 128x112 pixels, IP54 protection	1	0.360

Alarm-status relay unit



RGK RR

Order code	Description	Qty per pkg	Wt [kg]
RGK RR	Remote unit for alarms/status, 12/24VDC, 12 relay outputs, pulse input, CANbus communication port	1	0.420

Remote display panel characteristics

For remote controller supervision and viewing, the user operates the remote display panel as if directly in front of the generating set.

- 12/24VDC battery power supply
- Graphic LCD with backlight:
 - 128x80 pixels for RGK 800...
 - 128x112 pixels for RGK 900...
- 13 function and setting keys
- 10 Indication LEDs for operating modes and status
- Built-in buzzer
- 4 digital inputs
- 2 digital outputs
- Conductor cross section: 0.2-2.5mm² (24-12 AWG; 18-12 AWG per UL/CSA)
- Tightening torque: 0.56Nm (4.5lbin)
- Front degree of protection: IEC IP65; UL/CSA Type 4X outdoor enclosure installation
- Serial interface ports: opto-isolated RS485 (RGK...RD); CANbus-J1979 (RGK...SA).

Remote annunciator characteristics

Alarm conditions can be viewed on the remote display and alarm silencing can also be activated.

- Dual 100-240VAC / 12-24VDC power supply
- Touch screen 120x112 pixel backlight graphic LCD
- Built-in buzzer
- Static (SSR) output for global alarm signalling
- Opto-isolated RS485 interface port
- Conductor cross section: 0.2-2.5mm² (24-12 AWG; 18-12 AWG per UL/CSA)
- Tightening torque: 0.56Nm (4.5lbin)
- Front degree of protection: IEC IP54; UL Type 1.

Alarm-status relay unit characteristics

External relay expansion unit for alarm and status remoting.

Fixing on 35mm DIN rail (IEC/EN 60715).

Communication with RGK... controllers by CANbus or pulse inputs:

- 12 relay outputs of which 5 with changeover (SPDT) contact rated 5A 250VAC / B300 and 7 N/O (SPST) contact rated 2.5A 250VAC / C300
- 12/24VDC power supply
- Up to 2 RGK RR units can be connected in cascade for a total of 24 relays
- Maximum installation distance from the RGK 6... and RGK 700... RGK 900 controllers:
 - CANbus: 30m/33yd (high speed)
 - Inputs/Outputs: 1,000m/1,094yd (low speed)
- Conductor cross section: 0.2-2.5mm² (24-12 AWG)
- Tightening torque: 0.56 Nm/4.5lbin.

Certifications and compliance

Certifications obtained: EAC; UL Listed, for USA and Canada (cULus – File E93601), as Auxiliary Devices, Generator controllers remote and relay units for all except pending for RGK900... types.

Comply with standards: IEC/EN 61010-1, IEC/EN 61000-6-2, IEC 61000-6-3, UL508, CSA C22.2 n° 14.

For wiring schemes and technical characteristics, refer to technical instructions in Downloads of local or global website or consult Customer Service; see contact details on inside front cover.

Communication devices for RGK 600... - RGK 700... RGK 800... - RGK 900...



CX 01



CX 02



CX 03

Order code	Description	Qty per pkg	Wt
		n°	[kg]
CX 01	USB/optical dongle with PC↔controller connecting cable for programming, data download, diagnostics and firmware upgrade	1	0.090
CX 02	Wi-Fi dongle for PC ↔ controller programming, data download, diagnostics and firmware upgrade, project upload/download and controller cloning	1	0.090
CX 03	GSM/GPRS quad-band antenna (800/900/1800/1900MHz) for EXP10 15 expansion module for RGK 800... - RGK 900...	1	0.090

General characteristics

Communication and connection devices for generating set controllers RGK 600-RGK 700-RGK 800-RGK 900... for personal computers, smartphones, tablets, modems, bus drives.

CX 01

The USB/optical connector, complete with cable, allows to connect RGK 600-RGK 700-RGK 800-RGK 900... controllers to a PC without having to disconnect the power supply from the electric panel and to carry out parameter programming, data and event download, diagnostics and firmware upgrade. The PC identifies the connection as a standard USB.

CX 02

By Wi-Fi connection, RGK 600..., RGK 700..., RGK 800... and RGK 900... controllers can be viewed by PC, smartphone and tablet with no need for cabling and to carry out parameter programming, data and event download, diagnostics project upload/download and controller cloning.

CX 03

Compatible with the major part of worldwide mobile networks thanks to the available frequencies at 800/900/1800/1900MHz. IP67 IEC protection degree. Fixing by Ø12mm/0.04" drilling.

For wiring schemes and technical characteristics, refer to technical instructions in Downloads of local or global website or consult Customer Service; see contact details on inside front cover.

Accessories



51 C4

Order code	Description	Qty per pkg	Wt
		n°	[kg]
Connecting cables.			
51 C2	For PC ↔ controller, 1.8m/2yd long	1	0.090
51 C3	For PC ↔ GSM modem 1.8/2yd long	1	0.210
51 C4	For PC ↔ RS232/RS485, converter drive, 1.8m/2yd long	1	0.147
51 C11	For PC ↔ TTL/RS232 communication port 2.8m/3yd long	1	0.090
RS232/485 converter drive.			
4 PX1	Opto-isolated, 220-240VAC power supply (110-120VAC on request) ①	1	0.600
For RGK 600.... and RGK 601... controllers.			
RGK X00	IP65 gasket seal for internal display frame	1	0.100

new

① RS232/RS485 opto-isolated converter drive, 38,400 Baud rate maximum, automatic or manual TRANSMIT line supervision, 220-240VAC ±10% (110-120VAC supply on request).

General characteristics

CONNECTING CABLES 51 C...

They are used to link the RGK... controllers to personal computers, modems, bus converters.

RS232/RS485 CONVERTER DRIVE

It can interface "slave" devices connected in an RS485 bus with a "master" equipped with RS232 interface port. When configured appropriately, it can also be used as RS485 repeater whenever the devices connected to the bus are many or the maximum distance among the bus devices is longer than the allowed.

GASKET SEAL

To increase the protection degree of RGK600/610 types to IEC IP65, the gasket needs to be installed in the fixing slot on the inside surface of the display frame.

Software



RGK SW10

Order code	Description	Qty per pkg	Wt
RGK SW10	Customisation manager software complete with 51 C2 connecting cable	1	0.246 [kg]

APP

Customisation manager software

Once installed on a personal computer, besides setting up all functional parameters of the controllers, this **RGK SW10** software allows to handle many types of data such as texts, analog sensor response definition (for fuel, pressure, temperature), current overload protection, logo or trademark display at power up and setup exit, custom information pages.

The user can enable and disable alarms along with defining the controller feedback for alarm conditions and saving projects with the described types of files in single blocks despite the fact that different projects can share certain files. For instance, two projects can have the same text file but distinct sensor response files.

The **Synergy** software provides for the remote control and supervision of the RGK... controllers. See details given in Section 27.

Its structure and applications are based on MS SQL relational database management system. Consulting is made through popular programs for Internet browsing available across different platforms and operating systems. It is a highly versatile system, simultaneously accessible to a large number of users/workstations via intranets, VPN or Internet.

APP for smartphone and tablet

Sam1 (Setup And Maintenance 1) application allows the user to program the controller, view alarm conditions, send commands, read measurements, download statistical data and events and send retrieved data by email. The connection is made by Wi-Fi with a smartphone or tablet using the CX02 dongle.

It is iOS and Android compatible. For more details, see Section 27 or consult Customer Service; see contact details on inside front cover.

ENGINE PROTECTION CONTROLLERS

RGK 20

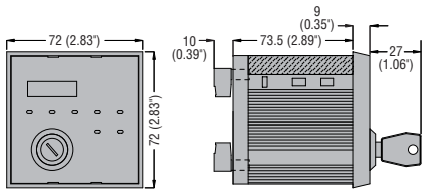

Cutout

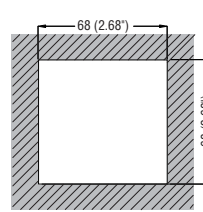

RGK 30

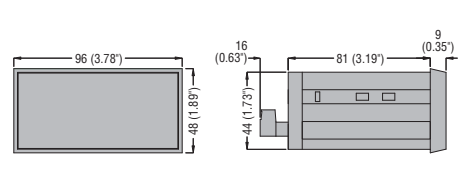

Cutout

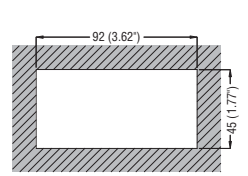

STAND-ALONE GEN-SET CONTROLLER

RGK 40

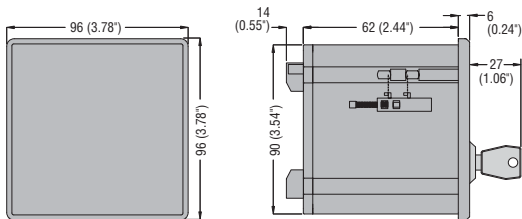

Cutout

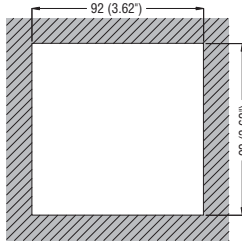

GEN-SET CONTROLLERS

RGK 600... - RGK 601...

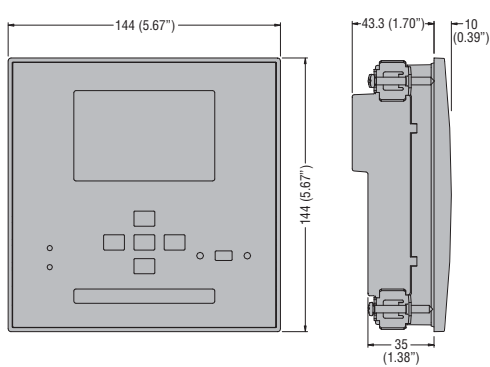

Cutout

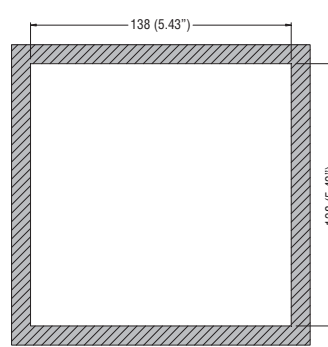

GEN-SET CONTROLLERS

RGK 700... - RGK 800... - RGK 900... - REMOTE DISPLAYS PANELS

RGK 800RD - RGK 800RDSA - RGK 900RD - RGK 900RDSA

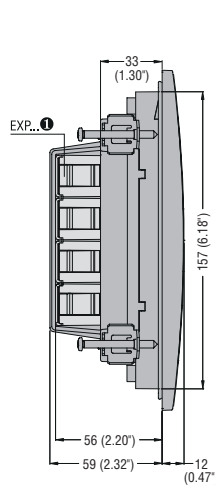
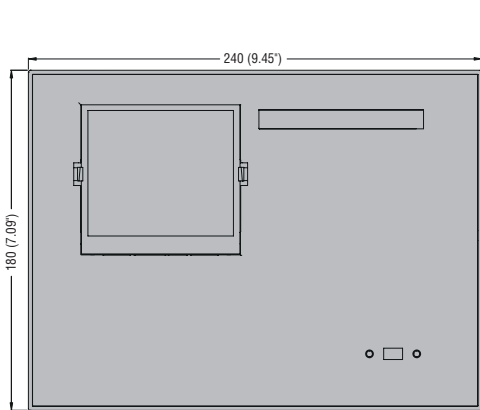

Cutout

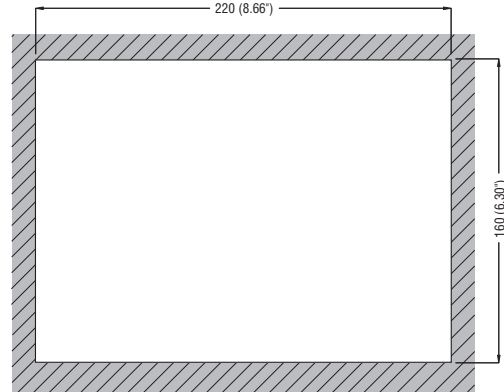

❶ RGK 700, RGK 800RD..., RGK 900RD... excluded.

REMOTE DISPLAY

RGK RA

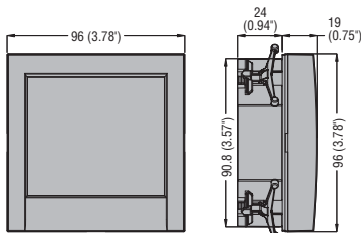

Cutout

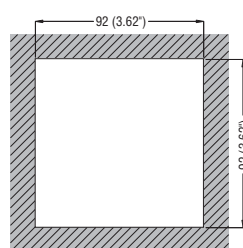

ALARM-STATUS RELAY UNIT

RGK RR

